

REV NO.	DATE	REVISION	DR	CH	APP
△					

SPECIFICATION

1. Rating : 150mA, DC 42V (Switching)
200mA, DC 42V (None-Switching)
2. Contact Resistance : 80mΩ Max
3. Insulation Resistance : 100MΩ Min at DC 250V
4. Operating Force : 700gf·cm Max
5. Life cycle : 10,000 steps
6. Sealing : IP67 (Dust & Water proof)
7. Packing : 50pcs Tube

Real Coded						
	C	1	2	4	8	
0	●				0	
1	●	●			1	
2	●		●		2	
3	●	●	●		3	
4	●			●	4	
5	●	●		●	5	
6	●		●	●	6	
7	●	●	●	●	7	
8	●				●	8
9	●	●			●	9
10	●		●		●	A
11	●	●	●		●	B
12	●			●	●	C
13	●	●		●	●	D
14	●		●	●	●	E
15	●	●	●	●	●	F

16 Position

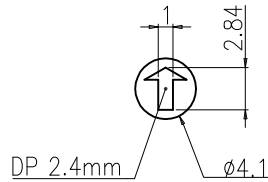

ACTUATOR

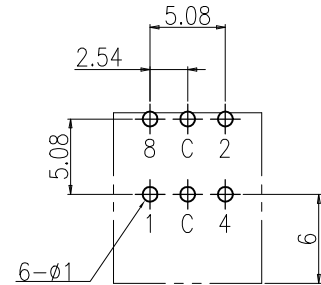
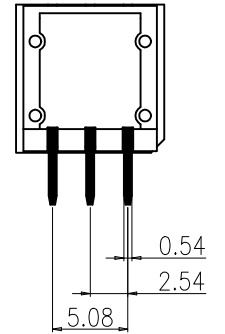
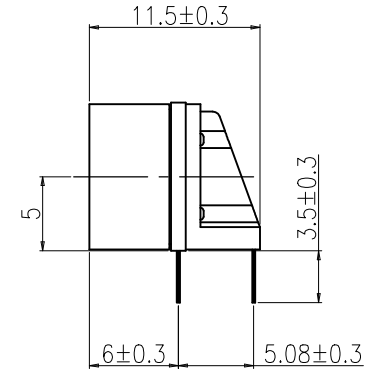
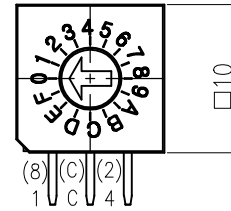

P.C.B DIMENSION (Top View)

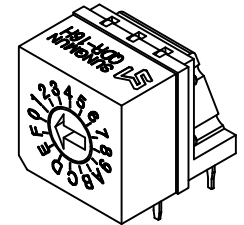
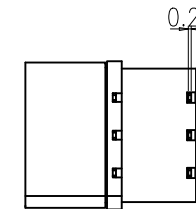

Din ISO-2768-1m					
Ranges	0.5~3	3~6	6~30	30~120	120~400
Tolerance	±0.1	±0.1	±0.2	±0.3	±0.5

DRAW/DESIGNED	CHECKED	APPROVED	G.TOL	SCALE	MODEL NO.	ROTARY DIP SWITCH	
H.S LEE	K.N KIM	WJ	mm	N:3		QDR-16H	REV.
2023-09-05	2023-09-05	2023-09-05		A4		QDR-16H(LG)-01	01

邦斯达 BONSUDA 深圳市子庚科技有限公司

